 INSTRUCTIONS	This manual contains important warnings and information. READ AND KEEP FOR REFERENCE.
--	--

Contractor™ In-line Valve

- For applying architectural paints and coatings -

- Model 244161, Series A (North America)**
3600 psi (25 MPa, 248 bar) Maximum Working Pressure
- Model 244364, Series A (Europe)**
3600 psi (25 MPa, 248 bar) Maximum Working Pressure
- Model 244365, Series A (Asia)**
3600 psi (25 MPa, 248 bar) Maximum Working Pressure

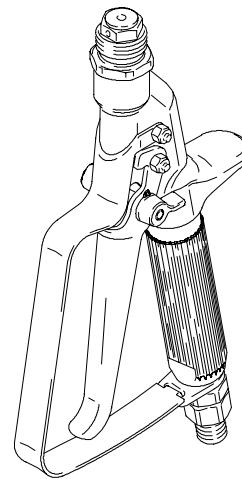

Table of Contents

Symbols	2
Installation	4
Operation	6
Parts	6
Parts List	12
Operation	13
Technical Data	14
Warranty	16
Graco Phone Number	16

WARNING: HIGH PRESSURE. Keep Clear of Nozzle. Read these instructions carefully.
--

Symbols

Warning Symbol



This symbol alerts you to the possibility of serious injury or death if you do not follow the instructions.

The wallet-sized warning card provided with the Contractor In-line Valve should be kept with the operator at all times. The card contains important treatment information should a fluid injection injury occur. Additional cards are available at no charge from Graco Inc.

Caution Symbol



This symbol alerts you to the possibility of damage to or destruction of equipment if you do not follow the instructions.

! WARNING



INJECTION HAZARD

Spray from the spray tip, hose leaks or ruptured components can inject fluid into your body and cause extremely serious injury, including the need for amputation. Splashing fluid in the eyes or on the skin can also cause serious injury.

- Fluid injected into the skin might look like just a cut, but it is a serious injury. **Get immediate surgical treatment.**
- Do not point the spray tip at anyone or any part of the body.
- Do not put hand or fingers over the spray tip, and do not stop or deflect fluid leaks with your hand, body, glove or rag.
- Do not “blow back” fluid; this is not an air spray system.
- Always have the tip guard and the trigger guard on the in-line valve when spraying.
- Be sure the trigger safety lever operates before operating the in-line valve.
- Lock the trigger safety lever when you stop spraying.
- Follow the **Pressure Relief Procedure** on page 4 when you are instructed to relieve pressure; stop spraying; check, clean, or service any system equipment; or install or change spray tips.
- Tighten all fluid connections before each use.
- Check the hoses, tubes and couplings daily. Replace worn or damaged parts immediately. Permanently coupled hoses cannot be repaired.
- Handle and route hoses and tubes carefully. Keep hoses and tubes away from moving parts and hot surfaces. Do not use the hoses to pull equipment. Do not expose Graco hoses to temperatures above 150°F (65°C) or below -40°F (-40°C).



TOXIC FLUID HAZARD

Hazardous fluids or toxic fumes can cause a serious injury or death if the fluid is swallowed or splashed in the eyes or on the skin or if the fumes are inhaled.

- Know the specific hazards of the fluid you are using.
- Store hazardous fluid in an approved container. Dispose hazardous fluid according to all local, state and national guidelines.
- Dress appropriately for your application. Wear protective eyewear, noise protection for the ears, a personal respirator, gloves, and clothing.



RECOIL HAZARD

Due to the high pressure fluid emitted, a strong recoil action may occur when you trigger the in-line valve. If you are unprepared, your hand could be forced back toward your body or you could lose your balance and fall, resulting in serious injury.

WARNING



FIRE AND EXPLOSION HAZARD

Improper grounding, poor air ventilation, open flames, or sparks can cause a hazardous condition and result in fire or explosion and serious injury.

- Ground the equipment and the object being sprayed. See **Electrical Grounding** on page 5.
- Provide fresh air ventilation to avoid the buildup of flammable fumes from solvent or the fluid being sprayed.
- Extinguish all the open flames or pilot lights in the spray area.
- Electrically disconnect all the equipment in the spray area.
- Keep the spray area free of debris, including solvent, rags, and gasoline.
- Do not turn on or off any light switch in the spray area while operating or if fumes are present.
- Do not smoke in the spray area.
- Do not operate a gasoline engine in the spray area.
- If there is any static sparking while using the equipment, **stop spraying immediately**. Identify and correct the problem.



INSTRUCTIONS

EQUIPMENT MISUSE HAZARD

Equipment misuse can cause the equipment to rupture, malfunction, or start unexpectedly and result in serious injury.

- This equipment is for professional use only.
- Read all instruction manuals, tags, and labels before operating the equipment.
- Use the equipment only for its intended purpose. If you are uncertain about the usage, call your distributor.
- Do not alter or modify this equipment. Use only genuine Graco parts and accessories.
- Check the equipment daily. Repair or replace worn or damaged parts immediately.
- Do not exceed the maximum working pressure of the lowest rated system component. This equipment has a **3600 psi (25 MPa, 248 bar) maximum working pressure**.
- Route the hoses away from the traffic areas, sharp edges, moving parts, and hot surfaces. Do not expose Graco hoses to temperatures above 150°F (65°C) or below -40°F (-40°C).
- Do not use the hoses to pull the equipment.
- Use fluids or solvents that are compatible with the equipment wetted parts. See the **Technical Data** section of all the equipment manuals. Read the fluid and solvent manufacturer's warnings.
- Fluid hoses must have spring guards on both ends to protect them from rupture caused by kinks or bends near the couplings.
- Comply with all applicable local, state and national fire, electrical and other safety regulations.
- Wear hearing protection when operating this equipment.



HAZARD OF USING FLUIDS CONTAINING HALOGENATED HYDROCARBONS

Never use 1,1,1-trichloroethane, methylene chloride, other halogenated hydrocarbon solvents or fluids containing such solvents in this equipment. Such use could result in a serious chemical reaction, with the possibility of explosion, which could cause death, serious injury and/or substantial property damage.

Consult your fluid suppliers to ensure that the fluids being used are compatible with aluminum and zinc parts.

Installation

Installation

1. Connect grounded fluid hose to the in-line valve.
2. Without the spray tip installed, start sprayer; flush and prime according to sprayer instructions.

NOTE: The Contractor In-line valve can be used as an airless spray gun by attaching a HandTite™ Guard and RAC5 SwitchTip™.

3.  Relieve the pressure following the **Pressure Relief Procedure** below.

Pressure Relief Procedure

⚠ WARNING

INJECTION HAZARD

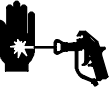
 To reduce the risk of serious injury, including fluid injection, splashing in the eyes or on skin, or injury from moving parts, always follow this procedure when you stop spraying; check or service any part of spray system; or install, clean, or change the spray tip.

1. Put in-line valve trigger safety lever in SAFETY ON position. Fig. 1.
2. Shut off power supply to pump. Open all air bleed valves in system.
3. Put in-line valve trigger safety lever in SAFETY OFF position. Fig. 1.
4. Hold metal part of in-line valve firmly to side of *grounded* metal waste container. Trigger in-line valve to relieve pressure.

5. Put in-line valve trigger safety lever in SAFETY ON position. Fig. 1.
6. Open pump drain valve to help relieve fluid pressure in pump, hose, and in-line valve. Triggering in-line valve to relieve pressure may not be sufficient. Have container ready to catch drainage.
7. Leave drain valve open until you are ready to spray again.

If you suspect that the spray tip or hose is completely clogged or that pressure has not been fully relieved after following the steps above, VERY SLOWLY loosen the tip guard retaining nut (Fig. 2) or hose end coupling and relieve pressure gradually, then loosen completely. Then clear tip or hose obstruction.

8. Install spray tip.

Required Accessories

⚠ WARNING

INJECTION HAZARD

 Your spray system must have a bleed-type master air valve and a fluid drain valve. They help reduce the risk of serious injury, including fluid injection, splashing in the eyes or on the skin, or injury from moving parts, if you are adjusting or repairing the pump or in-line valve.

- The *bleed-type master air valve* (air-powered pumps only) relieves air trapped between the valve and pump after the air regulator is shut off. Trapped air can cause the pump to cycle unexpectedly.
- The *fluid drain valve* assists in relieving fluid pressure in the displacement pump, hose and in-line valve. Triggering the in-line valve to relieve pressure may not be sufficient.

Installation

Electrical Grounding

 **WARNING**

 **FIRE AND EXPLOSION HAZARD**
Improper grounding could cause static sparking, which could cause a fire or explosion. To reduce the risk of property damage or serious injury, follow the grounding instructions below.

- Read and follow the warnings in **Fire and Explosion Hazard** on page 3.
- Provide electrical grounding continuity throughout the entire spray system as instructed below.
- Have a trained and qualified person perform all electrical wiring.
- Comply with all applicable local, state, and national fire, electrical, and other regulations.

The following grounding instructions are minimum requirements for a system. Your system may include other equipment or objects that must be grounded. Check your local electrical code for detailed grounding instructions for your area and type of equipment. Your system must be connected to a true earth ground.

- Ground the **pump or sprayer** as instructed in its separate manual.
- Ground the **air compressor or hydraulic power supply** according to the local electrical code and the manufacturer's recommendations.
- Use electrically conductive **fluid hoses** with a maximum combined hose length of 500 feet (150 m) to ensure grounding continuity.
- Ground the **in-line valve** by connecting it to a properly grounded fluid hose and pump or sprayer.
- Ground the **fluid supply container, object being sprayed, all solvent pails used when flushing** according to the local electrical code. Use only metal pails, which are conductive. Do not place the pail on a non-conductive surface, such as paper or cardboard, which interrupts the grounding continuity.
- **To maintain grounding continuity when flushing or relieving pressure**, always hold a metal part of the in-line valve firmly to the side of a *grounded* metal pail, then trigger the in-line valve.

Operation

WARNING



INJECTION HAZARD

To reduce the risk of a fluid injection injury, do not operate the in-line valve with the tip guard or trigger guard removed.

In-Line Valve Trigger Safety Lever

For SAFETY ON position, rotate trigger safety lever so it is in line with trigger. For SAFETY OFF position, flip safety lever so it is 90° to trigger. Fig. 1.

NOTE: In the SAFETY ON position the lever sits in a detent which holds it in place.

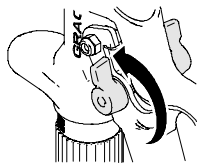

SAFETY ON

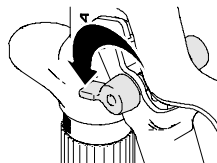

SAFETY OFF

Fig. 1

Startup

NOTE:

- The Contractor In-line Valve can be used as an airless spray gun by attaching a HandTite Guard and RAC5 Switches.
- When connecting extension poles to the Contractor In-line Valve, use a wrench to tighten.

1. Start pump. Adjust fluid pressure so spray is completely atomized. Always use lowest pressure that gets desired results. Higher pressure may not improve spray pattern and causes premature tip and pump wear.

NOTE: The spray tip orifice size and spray angle determine the coverage and size of the pattern. When more coverage is needed, use a larger spray tip rather than increasing the fluid pressure.



2.

If adjusting the pressure does not give a good spray pattern, try another size tip. **Relieve the pressure** before you change the spray tip.

3. Use full-open, full-close trigger action. Hold tip at a right angle to the work surface, about 14 inches (350 mm) away. Do not swing in-line valve in arcs. Practice to find the best length and speed of stroke.

Operation

Changing Spray Pattern Orientation

WARNING



To reduce the risk of a fluid injection injury, never spray without the tip guard.

The orientation of the tip guard indicates the orientation of the spray pattern.

1. Fig. 1. Put in-line valve trigger safety lever in SAFETY ON position.
2. Fig. 2. Turn the tip guard by hand to change the orientation.

NOTE: You may have to loosen the retaining nut to turn the tip guard by hand.

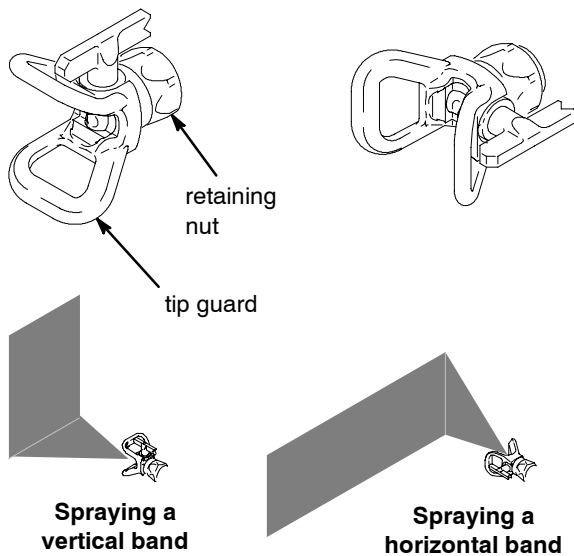

Fig. 2

CAUTION

The openings in the tip guard are designed to reduce paint buildup on the guard while spraying. Any damage to the sharp edges of the openings causes paint to collect at that area. To avoid damaging the tip guard, do not hang the in-line valve by the tip guard.

Clearing a Clogged Spray Tip

Frequently during the job and at the end of each workday, **relieve the pressure** and manually clean the tip with a solvent-soaked brush. Frequent cleaning helps keep fluid buildup from drying and clogging the spray tip.

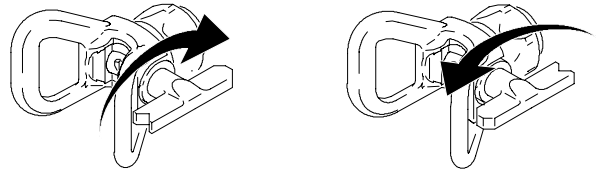

UNCLOG position
Fig. 3

SPRAY position

Use the Reversible Spray Tip to quickly clear clogs as follows:

1. Fig. 1. Put in-line valve trigger safety lever in SAFETY ON position.
2. Fig. 3. Rotate arrow-shaped handle to UNCLOG position.
3. Fig. 1. Put in-line valve trigger safety lever in SAFETY OFF position, and trigger in-line valve into pail or onto ground to remove clog.
4. Fig. 3. Put in-line valve trigger safety lever in SAFETY ON position (Fig. 1), and rotate arrow-shaped handle to SPRAY position.

If spray tip is still clogged, relieve the pressure by following the **Pressure Relief Procedure** on page 4 and manually clean it. To reduce tip clogs, strain the fluid you are spraying.

WARNING



INJECTION HAZARD

To reduce risk of an injection or splashing fluid in eyes or on skin, follow these precautions before you remove, clean, or change a spray tip or tip guard.

- Do not hold your hand, body, or rag in front of spray tip when cleaning or checking clogged tip.
- Always point tip toward ground or into waste container when checking to see if it is cleared.
- Do not try to “blow back” paint; this is NOT an air spray system.
- Follow **Pressure Relief Procedure** on page 4 before you wipe fluid buildup off spray tip, before you remove tip guard or spray tip, and whenever you are instructed to relieve the pressure.

Operation

Flushing the Contractor In-Line Valve

Always flush the in-line valve thoroughly when you stop spraying for the day and before the fluid being sprayed can dry or set up in the system.

WARNING



FIRE AND EXPLOSION HAZARD

To reduce the risk of a serious injury from fluid injection, static sparking, or splashing fluid in the eyes on or the skin, follow these precautions when flushing:

- Be sure entire system and flushing pails are properly grounded. See **Electrical Grounding** on page 5.
- Remove spray tip.
- Use lowest possible fluid pressure.
- Maintain firm metal-to-metal contact between in-line valve and pail during flushing.
- Follow the **Pressure Relief Procedure** on page 4 whenever you are instructed to relieve pressure.

1. Use a solvent that is compatible with wetted parts of in-line valve, rest of system, and material being sprayed.
2. Follow flushing instructions for your spray system or pump.
3. If flushing with water, flush last with a rust inhibitor or Graco Pump Armor to protect the system from corrosion.
4. If necessary, disassemble the Contractor In-line Valve and clean all passages thoroughly with a soft-bristled brush.

CAUTION

Do not soak the entire in-line valve in solvent. Prolonged exposure to solvent can ruin the packings.

Checking the In-Line Valve Diffuser Operation

Check the diffuser operation weekly. The in-line valve/diffuser/seat (A) breaks up spray and reduces the risk of fluid injection when the tip is not installed. Perform the test below. If it fails, replace the entire Needle Kit, Part No. 218070. Diffuser/seats are not sold separately since the in-line valve will leak if an old needle is used with a new diffuser/seat.

1. Follow **Pressure Relief Procedure** on page 4.
2. Remove the tip guard and spray tip.
3. Start the sprayer and adjust it to the lowest pressure.
4. Aim the in-line valve into a grounded metal pail while holding it firmly to the pail. Trigger the in-line valve. If the fluid emitted is not diffused into an irregular stream, replace the entire needle kit immediately.

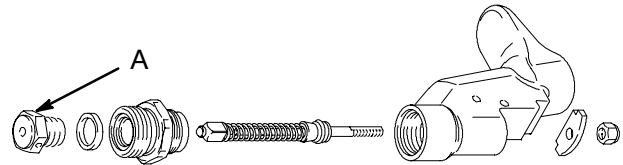

Fig. 4

Operation

Cleaning the Filter (Fig. 5)

Clean the filter assembly (5) daily, as follows:

1. Follow **Pressure Relief Procedure** on page 4.
2. Push up on the trigger guard (3) and swing it away from the trigger (2).
3. Unscrew the in-line valve handle (13) from the housing (11). Remove the filter and clean it in compatible solvent.
4. Apply lithium-base grease to the threads of the in-line valve handle (13) and reassemble in-line valve.

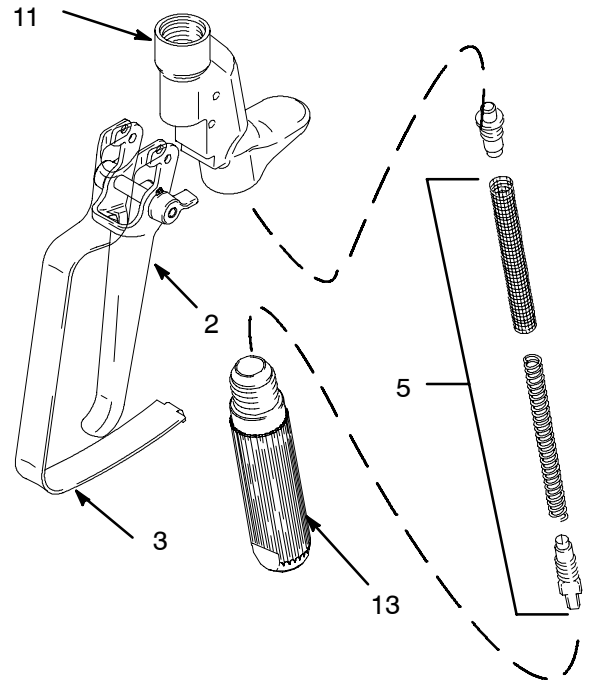

Fig. 5

Service

Changing the Needle (Fig. 6)

NOTE: Needle (C), diffuser/seat (A), gasket (B) and locknut (D) must be replaced together. They are included in Repair Kit 218070.

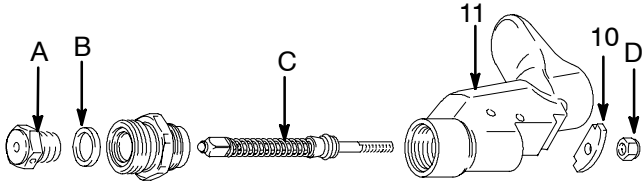

Fig. 6

Disassembly

1. Follow **Pressure Relief Procedure** on page 4.
2. Remove tip guard assembly.
3. Squeeze trigger while unscrewing diffuser/seat (A) and gasket (B).
4. Remove locknut (D) and bracket (10).
5. Tap rear of the in-line valve with a plastic mallet and punch to push needle assembly out through front of housing.

Reassembly

1. Guide threaded end of needle assembly into front of in-line valve.

2. Install bracket (10) and locknut (D) loosely on threaded end of needle (C). Squeeze trigger to pull needle assembly (C) into in-line valve body (11). Tighten locknut (D) as required to install needle (C).
3. Squeeze trigger while installing gasket (B) and diffuser/seat (A). Torque diffuser/seat to 26-32 ft-lb (35-43 N•m).
4. If in-line valve handle (13) was removed, hand tighten into fluid housing (11). It should fit easily.
5. Adjust needle before using in-line valve.
6. Be sure trigger guard and tip guard are installed before using in-line valve.

Adjusting the Needle (Fig. 6)

1. Engage in-line valve safety latch.
2. Hold in-line valve with nozzle straight up.
3. Remove trigger guard (3). (Fig. 5).
4. Hold your finger against trigger with light pressure. Using a 5/16-in, open-ended wrench, turn locknut (D) clockwise until you feel trigger depress slightly.
5. Turn adjusting nut 3/4 turn counter-clockwise.
6. Connect fluid hose. Install tip guard and prime the system. Trigger in-line valve and release it. The fluid flow should stop immediately. Engage safety latch and try to trigger in-line valve. **No fluid should flow.** If the in-line valve fails either test, relieve pressure, disconnect hose and readjust needle.

Service

Replacing the Swivel (Fig. 7)

Disassembly

1. Follow **Pressure Relief Procedure** on page 4.
2. Push up on trigger guard (3) and rotate trigger guard away from trigger (2).
3. Unscrew in-line valve handle (13) from housing (11). Remove filter (5) and clean in compatible solvent.

Reassembly

1. Install filter assembly (5) in handle.
2. Insert handle and swivel assembly in housing (11). Screw tight.

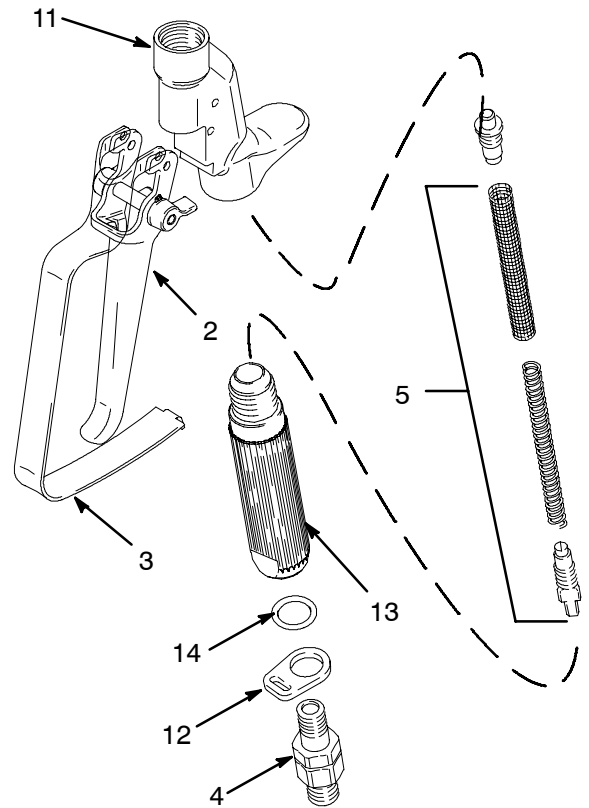

Fig. 7

Parts

Model 244161 Contractor In-line Valve
(North America)

Model 244364 Contractor In-line Valve
(Europe)

Model 244365 Contractor In-line Valve (Asia)

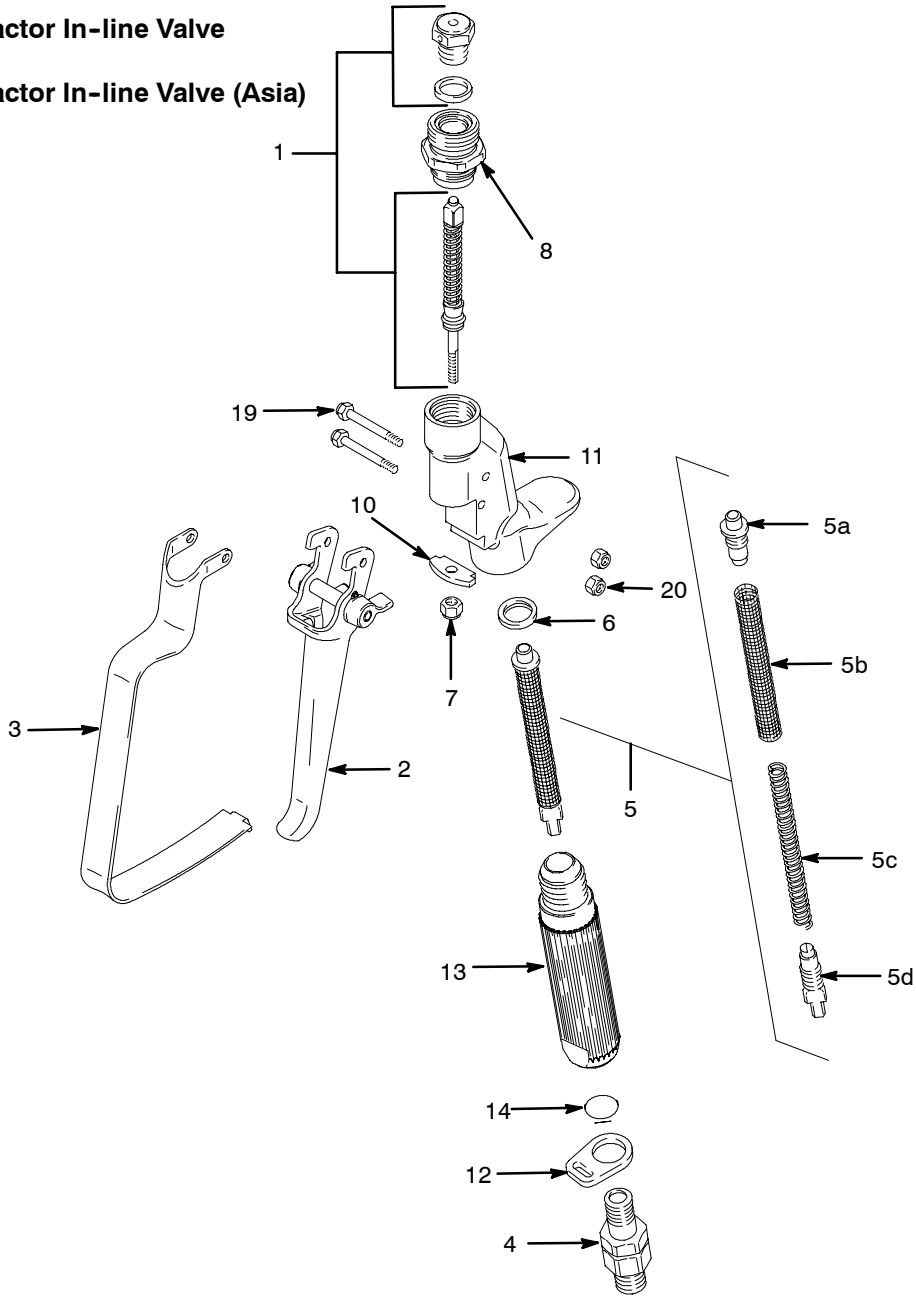

T10667

Parts List

Model 244161 Contractor In-line Valve (North America)

Model 244364 Contractor In-line Valve (Europe)

Model 244365 Contractor In-line Valve (Asia)

Ref. No.	Part No.	Description	Qty.	Ref. No.	Part No.	Description	Qty.
1	218070	NEEDLE-DIFFUSER/SEAT KIT	1	11	197568	HOUSING, fluid, locking (North America/Asia)	1
2	244193	TRIGGER, valve, in-line	1		196828	HOUSING, fluid (Europe)	1
3	196869	GUARD, trigger	1	12	113409	RETAINER, guard	1
4	238817	KIT, swivel	1	13	195788	HANDLE, valve (North America/Europe)	1
5✓	218131	FLUID FILTER ASSEMBLY (standard 50 mesh) includes replacement parts 5a, 5b, 5c, 5d	1		243393	HANDLE, valve (Asia)	1
5a	179722	RETAINER, spring	1	14	104938	PACKING, o-ring	1
5b	179731	ELEMENT, strainer	1	19	177538	STUD, trigger	2
5c	179763	SPRING, compression	1	20	105334	NUT, lock, hex	2
5d	179750	RETAINER, spring	1	21▲	222385	WARNING CARD (not shown)	1
6✓	179733	SEAL, sleeve	1	23▲	187348	COVER, warning	1
7	107110	LOCKNUT	1				
8	197052	ADAPTER, RAC	1				
10	197058	BRACKET, stem	1				

▲ Replacement Danger and Warning labels, tags and cards are available at no cost.

✓ Keep these spare parts on hand to reduce down time.

● Part number provided for reference only. Not available as a replacement part.

Technical Data

Maximum fluid working pressure	3600 psi (25 MPa, 248 bar)
Fluid inlet size	1/4 npsm (swivel)
Fluid outlet size	7/8-14 unf
In-line valve fluid valve orifice size	0.125 in. (2.286 mm) dia.
Wetted parts	UHMWPE, aluminum, tungsten carbide, stainless steel, PTFE, brass
Maximum material temperature	120°F (50°C)
Weight	
Model 244161, 244364, 244365	16.3 oz (0.462 kg)
Sound data *	
Sound pressure level	78 dB(A)
Sound power level	87 dB(A)
* Measured while spraying waterbase paint – specific gravity 1.36 through a 517 tip at 3,000 psi (21 MPa, 207 bar) per ISO 3744. Actual sound levels may vary with length of extension used.	

Graco Standard Warranty

Graco warrants all equipment manufactured by Graco and bearing its name to be free from defects in material and workmanship on the date of sale to the original purchaser for use. With the exception of any special, extended, or limited warranty published by Graco, Graco will, for a period of twelve months from the date of sale, repair or replace any part of the equipment determined by Graco to be defective. This warranty applies only when the equipment is installed, operated and maintained in accordance with Graco's written recommendations.

This warranty does not cover, and Graco shall not be liable for general wear and tear, or any malfunction, damage or wear caused by faulty installation, misapplication, abrasion, corrosion, inadequate or improper maintenance, negligence, accident, tampering, or substitution of non-Graco component parts. Nor shall Graco be liable for malfunction, damage or wear caused by the incompatibility of Graco equipment with structures, accessories, equipment or materials not supplied by Graco, or the improper design, manufacture, installation, operation or maintenance of structures, accessories, equipment or materials not supplied by Graco.

This warranty is conditioned upon the prepaid return of the equipment claimed to be defective to an authorized Graco distributor for verification of the claimed defect. If the claimed defect is verified, Graco will repair or replace free of charge any defective parts. The equipment will be returned to the original purchaser transportation prepaid. If inspection of the equipment does not disclose any defect in material or workmanship, repairs will be made at a reasonable charge, which charges may include the costs of parts, labor, and transportation.

THIS WARRANTY IS EXCLUSIVE, AND IS IN LIEU OF ANY OTHER WARRANTIES, EXPRESS OR IMPLIED, INCLUDING BUT NOT LIMITED TO WARRANTY OF MERCHANTABILITY OR WARRANTY OF FITNESS FOR A PARTICULAR PURPOSE.

Graco's sole obligation and buyer's sole remedy for any breach of warranty shall be as set forth above. The buyer agrees that no other remedy (including, but not limited to, incidental or consequential damages for lost profits, lost sales, injury to person or property, or any other incidental or consequential loss) shall be available. Any action for breach of warranty must be brought within two (2) years of the date of sale.

Graco makes no warranty, and disclaims all implied warranties of merchantability and fitness for a particular purpose in connection with accessories, equipment, materials or components sold but not manufactured by Graco. These items sold, but not manufactured by Graco (such as electric motors, switches, hose, etc.), are subject to the warranty, if any, of their manufacturer. Graco will provide purchaser with reasonable assistance in making any claim for breach of these warranties.

In no event will Graco be liable for indirect, incidental, special or consequential damages resulting from Graco supplying equipment hereunder, or the furnishing, performance, or use of any products or other goods sold hereto, whether due to a breach of contract, breach of warranty, the negligence of Graco, or otherwise.

FOR GRACO CANADA CUSTOMERS

The parties acknowledge that they have required that the present document, as well as all documents, notices and legal proceedings entered into, given or instituted pursuant hereto or relating directly or indirectly hereto, be drawn up in English. Les parties reconnaissent avoir convenu que la rédaction du présente document sera en Anglais, ainsi que tous documents, avis et procédures judiciaires exécutés, donnés ou intentés à la suite de ou en rapport, directement ou indirectement, avec les procédures concernées.

TO PLACE AN ORDER, contact your Graco distributor, or call this number to identify the distributor closest to you:
1-800-690-2894 Toll Free

*All written and visual data contained in this document reflect the latest product information available at the time of publication.
Graco reserves the right to make changes at any time without notice.*

This manual contains English: mm 309315

Graco Headquarters: Minneapolis
International Offices: Belgium, Korea, China, Japan

GRACO INC. P.O. BOX 1441 MINNEAPOLIS, MN 55440-1441

www.graco.com

2/2001, Rev 06/2009